

6 **OPTIONAL CORD CLEAT**

Although the cord cleat is an option, we recommend its use to improve child safety. Find a convenient location for the cord cleat a few inches to the right of the shade. The location should be high enough that it is out of the reach of young children. Hold the cord cleat up parallel to the shade and make pencil marks in the holes. Install using the two small cord cleat screws provided. Once installed, wind cords around the cleat in figure eights.

OPERATION:

Keep the cord close to the plane of the fabric when operating the shade; for best results do not pull cord away from the shade more than 15°. To disengage the locking mechanism, move the cord toward the center of the shade approximately 30° from the vertical position. Raise or lower the shade while holding the cord at this angle. To engage the locking mechanism, return the cord to the vertical position.

PROPER CARE OF CELLULAR SHADES

Shade may be vacuumed or cleaned with a mild detergent and soft brush. Allow to dry completely before raising.

BLINDS *please.*

Cellular Shades

ARCH INSTALLATION - INSIDE MOUNT

For installation, you will need the following tools:

1. Steel tape measure
2. Phillips screwdriver
3. Long, flat head screwdriver
4. Scissors
5. Drill w/ 3/32" bit (recommended)

Your Cellular shades come with the following components:

- Standard Brackets (amount shown on chart below)
- Specialty End Mount Brackets (optional)
- Mounting Screws
- Arch Support Clips
- Arch Center Cap

Mounting screws are included for wood or sheet metal surfaces. Expansion or toggle bolts are required with non-solid surfaces, such as drywall, lath or plaster. They are available at any hardware store.

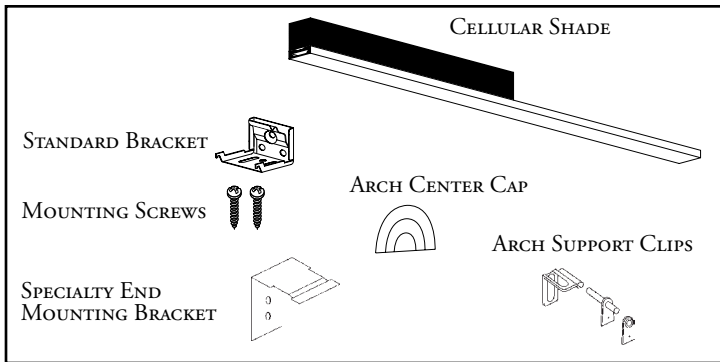

SHADE WIDTH	NUMBER OF BRACKETS
Up to 31"	2
31" - 65"	3
65" - 96"	4
96" - 126"	5
126"- 144"	6

1 Your order will arrive with a filler strip inserted into the bottom cell of the fabric stack. Open the cellular arch and slide the filler strip through the rest of the bottom cell. Then insert the bottom cell and filler strip into the grooves on the rail, using the large grooves on a stand-alone arch. For arches sharing the headrail with a standard shade, remove a headrail endcap and insert the arch's bottom cell and filler strip into the small grooves on the top of the headrail.

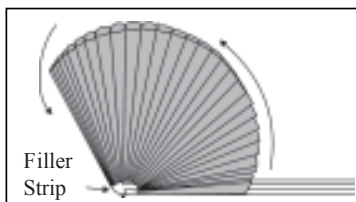

2

Center the fan on the rail. Then put the endcaps on the rail, as well as insert the arch center cap.

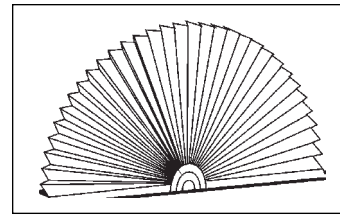

3

STAND-ALONE ARCHES:

The flat surface of the window casement must be at least 1 1/8" deep for a small rail, and 1 1/2" deep for large rail to attach the installation brackets. To fully recess the shade, the flat surface must be at least 2 1/2" for small rail and 3 1/2" deep for large rail.

A) Hold the arch and headrail in the desired location and mark the headrail's location. Two installation brackets should be positioned on the mounting surface so that their centerlines will be 2 1/4" in from the ends of the shade. If additional brackets are required (see chart), space evenly between the two end brackets. Align the mounting brackets accordingly and mark the screw locations. B) Drill at each mark. C) Mount brackets with supplied screws.

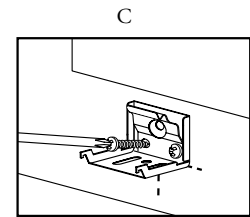
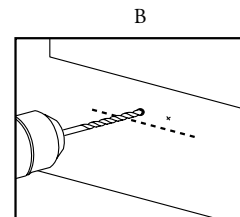
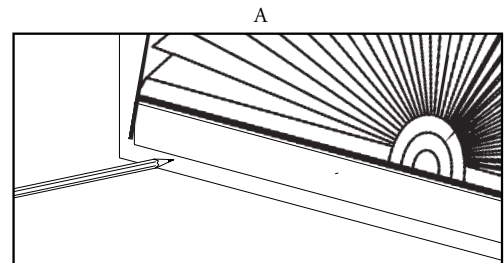

4

With the front of the fabric facing you, hook the headrail into the front of the installation brackets. The front lip on the bracket goes into the front groove on the top of the headrail. Make sure there is no fabric caught between the back of the bracket and the rail. Push the headrail up into the back of the bracket until you hear and feel the headrail snap into place.

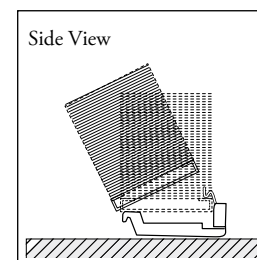

5

ARCH CLIPS:

Arch clips are designed to help hold the arch shade fabric in the desired position and prevent it from sagging. You have been supplied with the necessary quantity of arch clips to accommodate your particular arch. The clips consist of three separate pieces: A) Base, B) Male Clip, C) Female Clip.

SHADE WIDTH	NUMBER OF ARCH SUPPORT CLIPS
Up to 23"	1
23" - 46"	3
46" - 69"	5
69" - 84"	7

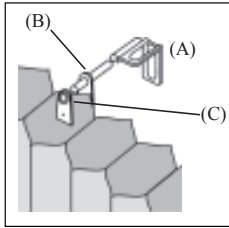

6

Position the first clip base (A) at the top center of the arch, keeping the arch face vertical. Mark the screw location. Then drill at the mark and mount the base with a screw. A hollow wall plug may be necessary if wood is not found.

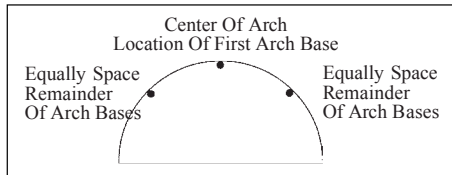

Space the remaining arch clip bases (A) provided equally on each side of the center arch clip base. Then mark their location and mount them at the same depth as the center clip, keeping the face of the arch vertical.

7

Find the center pleat of the arch shade. Place a male clip (B) at the back of that cell and the female clip (C) at the front of the back cell. Pinch the fabric between the male and female parts (B and C) by firmly pressing them together until you feel them lock in place. Repeat at each clip base location.

8

Insert the long post of the male clip (B) into its corresponding clip base (A). Push clip assembly into the base until you feel it snap into place, then push into the desired depth (there are 4 depth adjustments).

OPTIONAL: SPECIALTY END MOUNT INSTALLATION

After Step 1 is complete, pull the cord lock out of the headrail about 1/2". Then insert the bracket into the small grooves in the headrail, so that the bracket points down. Set the arch rail on top of the shade rail and push the bracket and cordlock into the rails. At the other end of the rails, install the bracket over the endcap.

For specialty end mount arches, the bracket ends point down. To fully recess the arch, the window opening must be at least 1 1/4" deep for small rail and 2 1/4" deep for large rail.

Hold the shade/arch in the desired position. Use a level to ensure shade is perfectly horizontal. Then mark the bracket's screw holes. Drill at each mark.

Hold the shade/arch in the desired position again, lining up the drilled holes with the bracket's holes. Gently pull the fabric forward to install the mounting screw. Be careful not to damage, crease or wrinkle the fabric. Install the mounting screws.

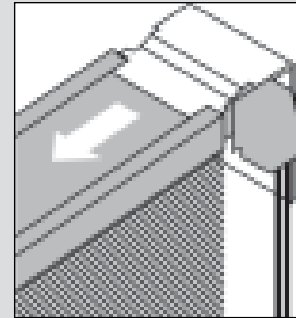

Cellular Shades

ARCH INSTALLATION - OUTSIDE MOUNT

For installation, you will need the following tools:

1. Steel tape measure
2. Phillips screwdriver
3. Long, flat head screwdriver
4. Scissors
5. Drill w/ 3/32" bit (recommended)

Your Cellular shades come with the following components:

- Standard Brackets (amount shown on chart below)
- Specialty End Mount Brackets (optional)
- Mounting Screws
- Arch Support Clips
- Arch Center Cap

Mounting screws are included for wood or sheet metal surfaces. Expansion or toggle bolts are required with non-solid surfaces, such as drywall, lath or plaster. They are available at any hardware store.

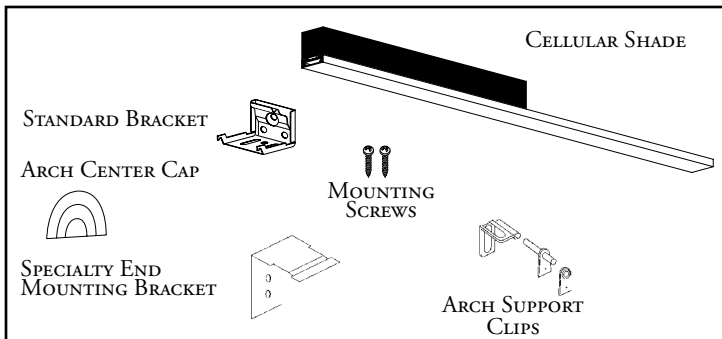

SHADE WIDTH	NUMBER OF BRACKETS
Up to 31"	2
31" - 65"	3
65" - 96"	4
96" - 126"	5
126" - 144"	6

1 Your order will arrive with a filler strip inserted into the bottom cell of the fabric stack. Open the cellular arch and slide the filler strip through the rest of the bottom cell. Then insert the bottom cell and filler strip into the grooves on the rail, using the large grooves on a stand-alone arch. For arches sharing the headrail with a standard shade, remove a headrail endcap and insert the arch's bottom cell and filler strip into the small grooves on the top of the headrail.

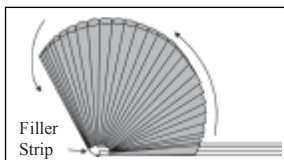

2

Center the fan on the rail. Then put the endcaps on the rail, as well as insert the arch center cap.

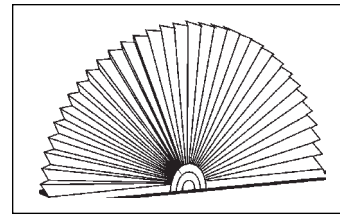

3

STAND-ALONE ARCHES:

Bracket attachment requires a flat vertical surface at least 3/4" high.

A) Hold the arch and headrail in the desired location and mark the headrail's location. Two installation brackets should be positioned on the mounting surface so that their centerlines will be 2 1/4" in from the ends of the shade. If additional brackets are required (see chart), space evenly between the two end brackets. Align the mounting brackets accordingly and mark the screw locations. B) Drill at each mark. C) Mount brackets with supplied screws.

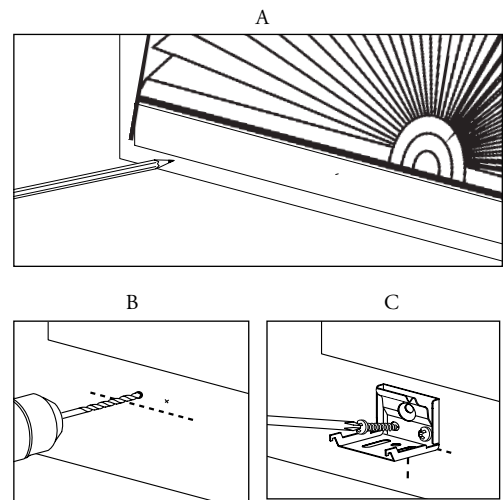

4

With the front of fabric facing you, hook the headrail into the front of the installation brackets. The front lip on the bracket goes into the front groove on the top of the headrail. Make sure there is no fabric caught between the back of the bracket and the rail. Push the headrail up into the back of the bracket until you hear and feel the headrail snap into place.

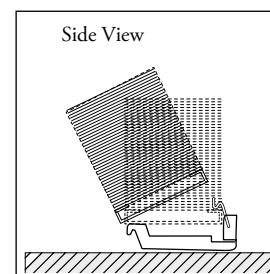

5 ARCH CLIPS:

Arch clips are designed to help hold the arch shade fabric in the desired position and prevent it from sagging. You have been supplied with the necessary quantity of arch clips to accommodate your particular arch. The clips consist of three separate pieces: A) Base, B) Male Clip, C) Female Clip.

SHADE WIDTH	NUMBER OF ARCH SUPPORT CLIPS
Up to 23"	1
23" - 46"	3
46" - 69"	5
69" - 84"	7

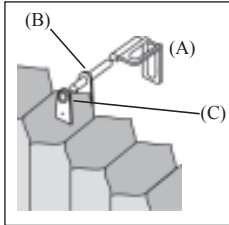

6 Find the center pleat of your arch shade fabric and the center of your arched window jamb. Hold the center of the fabric up at the center of the window jamb until you have reached the desired height. Place a small pencil mark on the wall at the top of the fabric. Position an arch clip base (A) with the top of the base approximately 3/8" above your pencil mark and mount with screw provided.

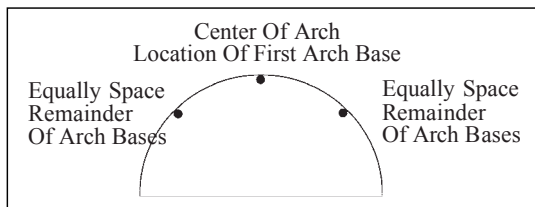

Space the remaining arch clip bases (A) provided equal distances on each side of the center arch clip base (A) and mount them at the same depth as the center one.

7 Find the center pleat of the arch shade. Place a male clip (B) at the back of that cell and the female clip (C) at the front of the back cell. Pinch the fabric between the male and female parts (B and C) by firmly pressing them together until you feel them lock in place. Repeat at each clip base location.

8 Insert the long post of the male clip into its corresponding clip base. Push clip assembly into the base until you feel it snap into place, then push into the desired depth (there are 4 depth adjustments).